

Technical Data Sheet

Wall Support - Heavy Duty Mounting Angle

Galvanized According To EN 10346



Master Data

Product Code	076.SA100150
Description 1	Wall Support
Description 2	Heavy Duty Mounting Angle
Dimension	100 x 150mm
Material	Steel
Surface Protection	Galvanized Steel According To EN 10346
Use	Dry Indoor Facilities
F in KN	1.25 KN

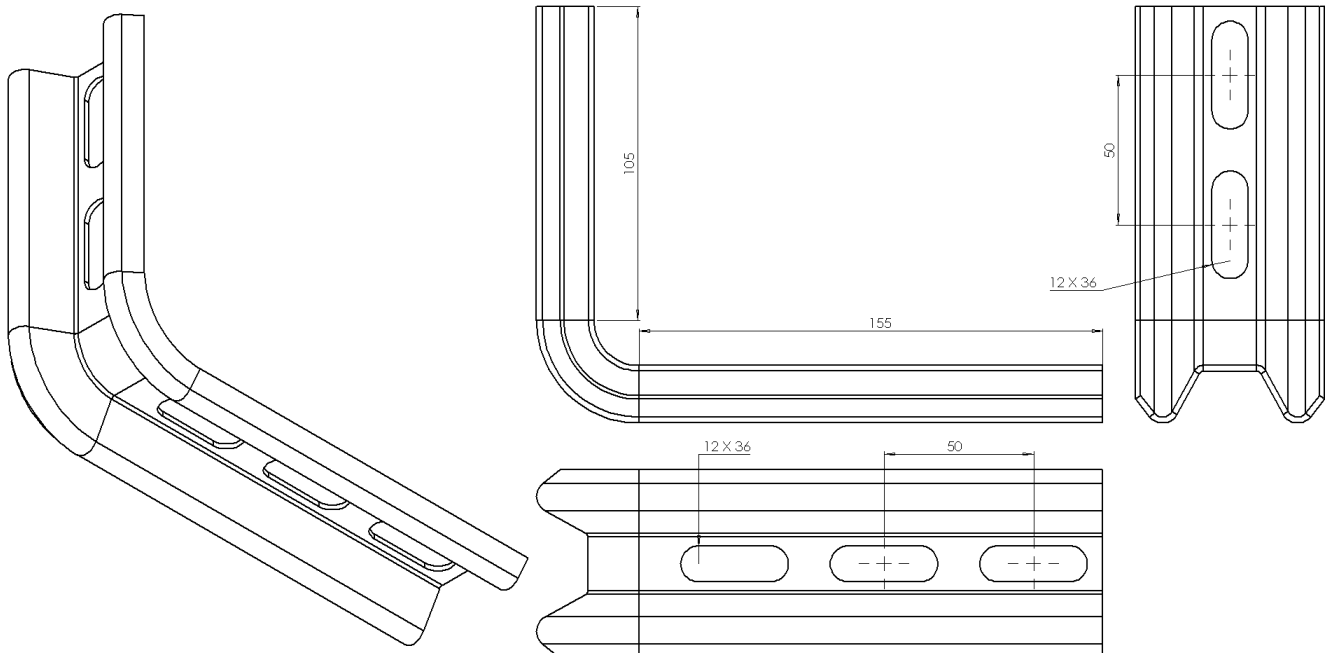

ISO 9001:2015